

Low Signal Relay G6S

Surface Mount DPDT Relay

- High dielectric withstand voltage of 2,000 VAC between coil and contacts (standard type); 1,500 VAC between contacts of different polarity.
- Meets FCC Part 68 and Telcordia 2.5 kV surge withstand.
- European version certified for EN60950/EN41003 Supplementary Insulation at 250 V at Pollution Degree 2.
- Low power consumption of 140 mW (Non-latching)
- Available in through-hole and SMT terminals.
- Tape and reel or tube packaging.
- RoHS Compliant.

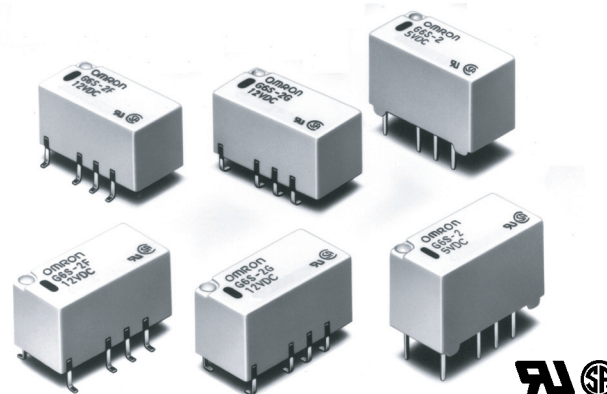

Ordering Information

Standard Version

Terminal	Model Contact form	Non-latching		Single coil latching	Dual coil latching
		Standard	European Version*		
Gull-wing	DPDT	G6S-2F	G6S-2F-Y	G6SU-2F	G6SK-2F
Inside "L"		G6S-2G	G6S-2G-Y	G6SU-2G	G6SK-2G
PCB through-hole		G6S-2	G6S-2-Y	G6SU-2	G6SK-2

* Certified for EN60950/EN41003 Supplementary Insulation at 250 V (pollution degree 2)

Notes: 1. When ordering, add the rated coil voltage to the model number.

Example: G6S-2F DC12
└─── Rated coil voltage

2. When ordering tape packing (surface mount models), add "-TR" to the model number.

Example: G6S-2F-TR DC12
└─── Tape packing

"-TR" is not part of the relay model number. Therefore, it is not marked on the relay case.

3. Dual coil latching models are available with a High-sensitivity coil. (140 mW; 200 mW for DC24)
 When ordering High-sensitivity dual coil latching models, add "-H" to the model number.

Example: G6SK-2G-H-TR DC5
└─── High-sensitivity coil

Model Number Legend

G6S - - - DC

1 2 3 4 5 6

1. Relay Function

- None: Non-latching
- U: Single coil latching
- K: Dual coil latching

3. Terminal Shape

- None: Through-hole
- F: Gull-wing surface mount
- G: Inside "L" surface mount

5. Packaging

- None: Tube packaging
- TR: Tape and reel packaging
(Surface mount models)

2. Contact Form

- 2: DPDT

4. Approved Standards

- None: UL/CSA
- Y: EN60950/EN41003
(Standard coil models)

6. Rated Coil Voltage

- 4.5, 5, 12, 24

Specification

■ Contact Data

Load	Resistive load (cos φ = 1)
Rated load	0.5 A at 125 VAC 2 A at 30 VDC
Contact material	Ag (Au clad)
Max. carry current	2 A
Max. operating voltage	250 VAC, 220 VDC
Max. operating current	2 A
Max. switching capacity	62.5 VA, 60 W
Min. permissible load	10 μA, 10 mVDC

Note: P level: $\lambda_{60} = 0.1 \times 10^{-6}$ /operation

This value was measured at a switching frequency of 120 operations/min and the criterion of contact resistance is 50 Ω. This value may vary depending on the operating environment. Always double-check relay suitability under actual operating conditions.

■ Coil Data

G6S - Standard Non-latching (G6S-2F, G6S-2G, G6S-2)

Rated voltage (VDC)	Rated current (mA)	Coil resistance (Ω)	Pick-up voltage	Dropout voltage	Maximum voltage	Power consumption (mW)
			% of rated voltage			
4.5	31.0	145	75% max.	10% max.	200% max. @ 23°C	Approx. 140
5	28.1	178				
12	11.7	1,028				
24	8.3	2,880			170% max. @ 23°C	Approx. 200

G6SU - Standard Single Coil Latching (G6SU-2F, G6SU-2G, G6SU-2)

Rated voltage (VDC)	Rated current (mA)	Coil resistance (Ω)	Coil Inductance (H) (ref. value)		Set pick-up voltage	Reset pick-up voltage	Maximum voltage	Power consumption (mW)	
			Armature OFF	Armature ON	% of rated voltage				
4.5	22.2	203	0.27	0.14	75% max.	75% max.	180% max. @ 23°C	Approx. 100	
5	20.0	250	0.36	0.18					
12	8.3	1,440	2.12	1.14					
24	6.3	3,840	5.80	3.79					
									Approx. 150

G6SK - Standard Dual Coil Latching (G6SK-2F, G6SK-2G, G6SK-2)

Rated voltage (VDC)	Rated current (mA)	Coil resistance (Ω)	Coil Inductance (H) (ref. value)				Set pick-up voltage	Reset pick-up voltage	Maximum voltage	Power consumption (mW)
			Set		Reset					
			Armature OFF	Armature ON	Armature OFF	Armature ON	% of rated voltage			
4.5	44.4	101	0.12	0.074	0.082	0.14	75% max.	75% max.	170% max. @ 23°C	Approx. 200
5	40	125	0.14	0.088	0.098	0.16				
12	16.7	720	0.60	0.41	0.46	0.54				
24	12.5	1,920	1.98	1.23	1.34	2.23				

G6S - European Version, Non-latching (G6S-2F-Y, G6S-2G-Y, G6S-2-Y)

Rated voltage (VDC)	Rated current (mA)	Coil resistance (Ω)	Pick-up voltage	Dropout voltage	Maximum voltage	Power consumption (mW)
			% of rated voltage			
5	40.0	125	75% max.	10% max.	170% max. @ 23°C	Approx. 200
12	16.7	720				
24	9.6	2,504				

Note: 1. The rated current and coil resistance are measured at a coil temperature of 23°C with a tolerance of ±10%.

2. The operating characteristics are measured at a coil temperature of 23°C.

3. Pick-up voltage will vary with temperature.

4. The maximum voltage is the highest voltage that can be imposed on the relay coil.

■ Characteristics

Contact resistance (See note 1)		75 mΩ max.
Operate (set) time (See note 2)		4 ms max. (mean value approx. 2.5 ms G6S; 2.0 ms G6SU, G6SK)
Release (reset) time (See note 2)		4 ms max. (mean value approx. 1.5 ms G6S; 2.0 ms G6SU, G6SK)
Bounce time		Approx. 0.5 ms
Max. operating frequency		Mechanical: 36,000 operations/hr Electrical: 1,800 operations/hr (under rated load)
Insulation resistance (See note 3)		1,000 MΩ min. (at 500 VDC)
Dielectric strength		2,000 VAC, 50/60 Hz for 1 minute (G6S, G6SU) between coil and contacts 1,000 VAC, 50/60 Hz for 1 minute (G6SK) between coil and contacts 1,500 VAC, 50/60 Hz for 1 minute between contacts of different poles 1,000 VAC, 50/60 Hz for 1 minute between contacts of same pole 500 VAC, 50/60 Hz for 1 minute between set and reset coils (G6SK)
Surge withstand voltage	Conforming to Telcordia specs.	2,500 V (2 x 10 μS) between coil and contacts for G6S and G6SU 2,500 V (2 x 10 μS) between contacts of different poles
	Conforming to FCC Part 68	1,500 V (10 x 160 μS) between coil and contacts for G6SK 1,500 V (10 x 160 μS) between contacts of same pole
Vibration	Mechanical durability	10 to 55 Hz; 5 mm double amplitude
	Malfunction durability	10 to 55 Hz; 3.3 mm double amplitude
Shock	Mechanical durability	1,000 m/s ² ; approx. 100 G
	Malfunction durability	750 m/s ² ; approx. 75 G
Ambient temperature		-40 to +85°C with no icing; -40 to +70°C with no icing (G6SK, DC24 coil)
Ambient Humidity		5% to 85% RH
Service life	Mechanical	100,000,000 operations min. (at 36,000 operations/hour)
	Electrical	100,000 operations min. (2A@30VDC, resistive; 1,200 ops/hr.) 100,000 operations min. (0.5A@125VAC, resistive) See "Characteristic Data"
Weight		Approx. 2g

- Note:**
1. The contact resistance was measured with 10 mA at 1 VDC with a voltage drop method.
 2. Values in parentheses are typical values unless otherwise stated.
 3. The insulation resistance was measured with a 500-VDC megohmmeter applied to the same parts as those used for checking the dielectric strength (except between the set and reset coil).
 4. Data shown are of initial value.

■ Characteristic Data

Service Life

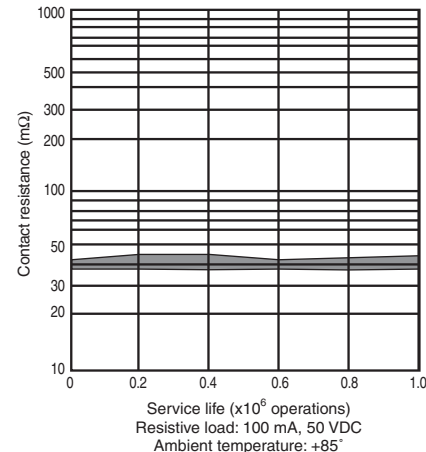
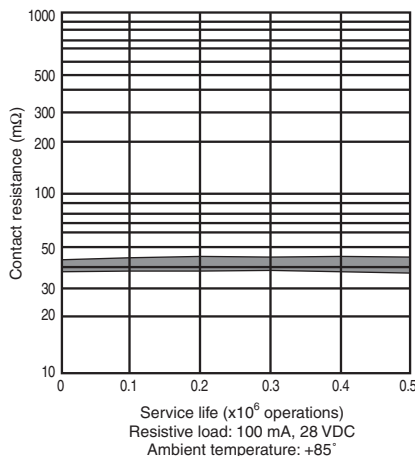
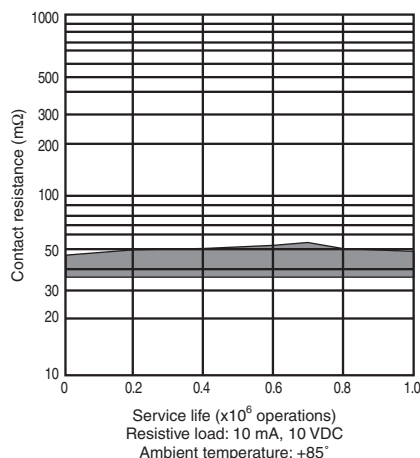

Maximum Switching Capacity

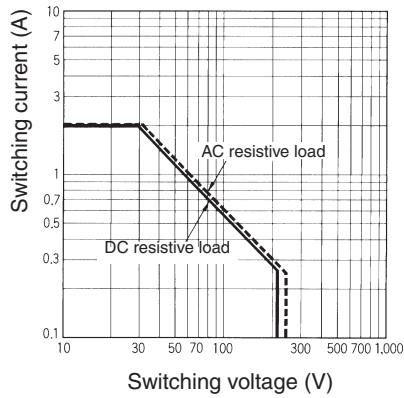

Ambient Temperature vs. Maximum Coil Voltage Non-latching

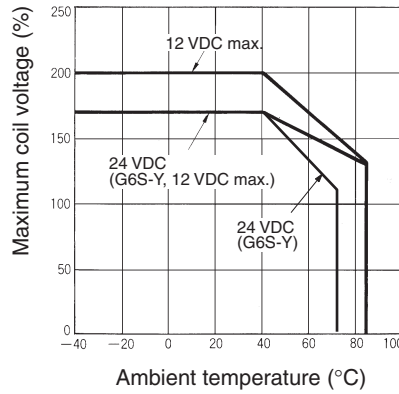

Single Coil Latching Dual Coil Latching

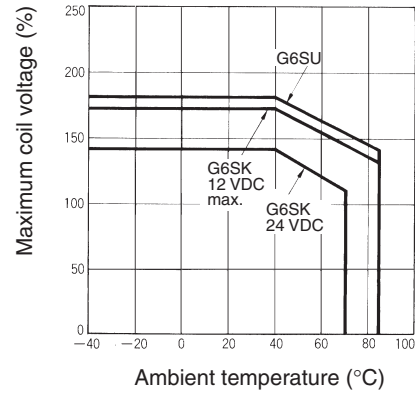

Note: The maximum coil voltage refers to the maximum value in a varying range of operating power voltage, not a continuous voltage.

Reference Data

Ambient Temperature vs. Switching Current Non-latching

Non-latching

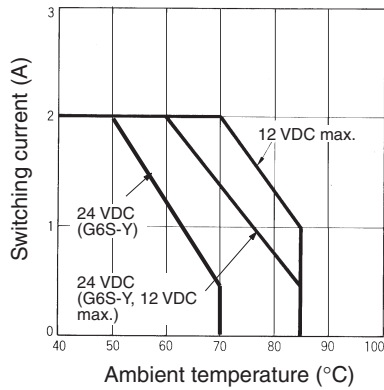

Single Coil Latching Dual Coil Latching

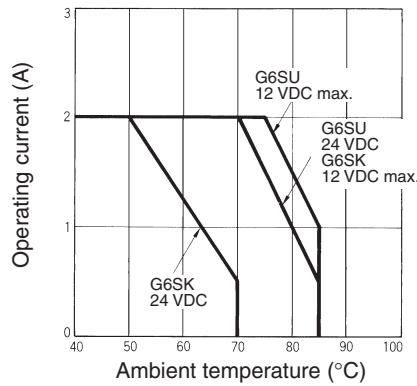

Electrical Service Life

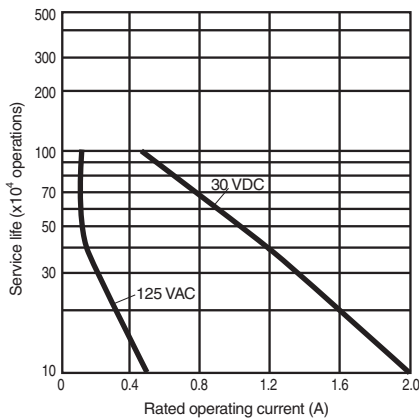

Dielectric Strength (Standard Version, Non-latching)

Detecting current: 1mA

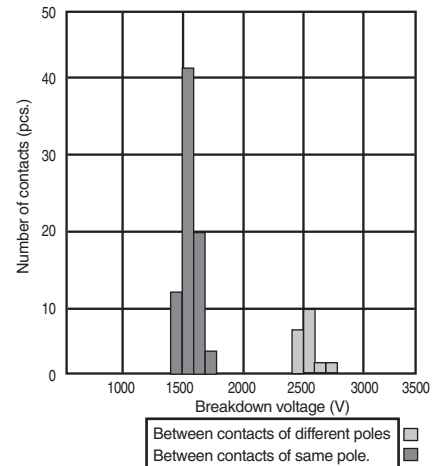
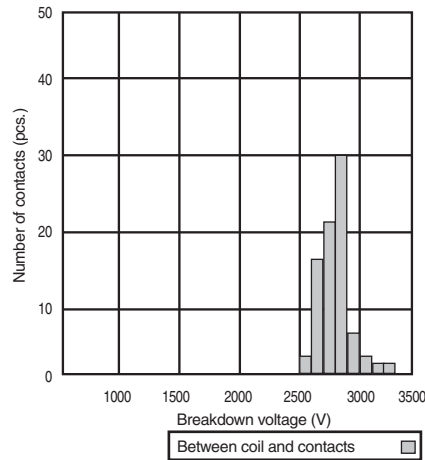

Impulse Withstand Voltage (Standard Version, Non-latching)

(2 x 10 ms)

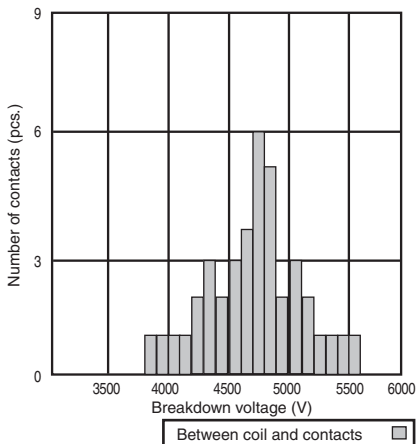

(10 x 160 ms)

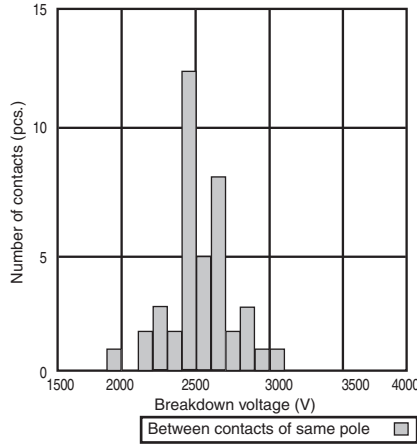

(10 x 160 ms)

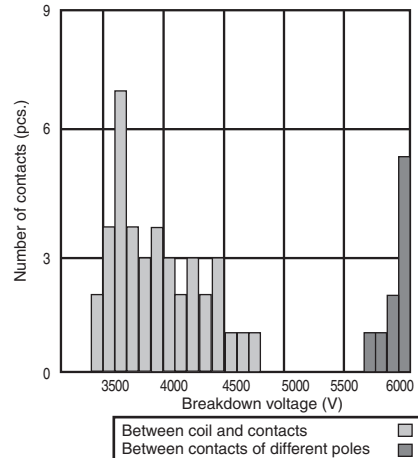

Impulse Withstand Voltage (European version)

(2 x 10 ms)

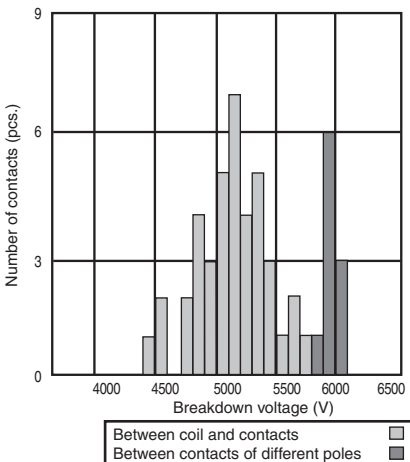

(10 x 160 ms)

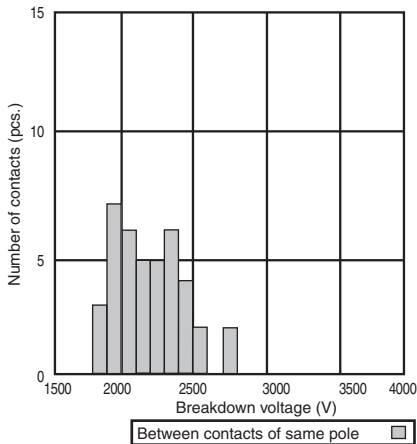

(10 x 160 ms)

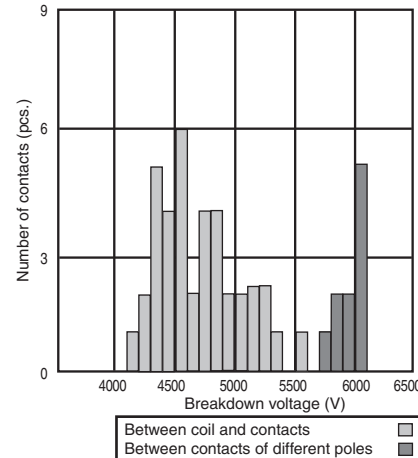

Dielectric Strength (European Version, Non-latching)

Detecting current: 1mA

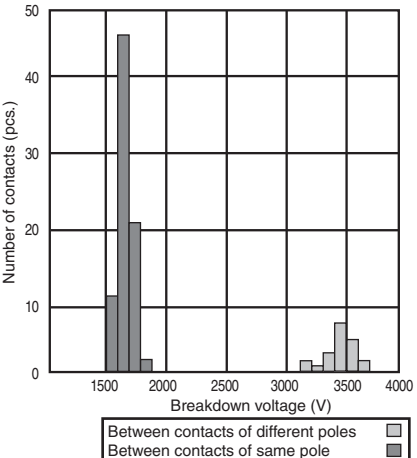
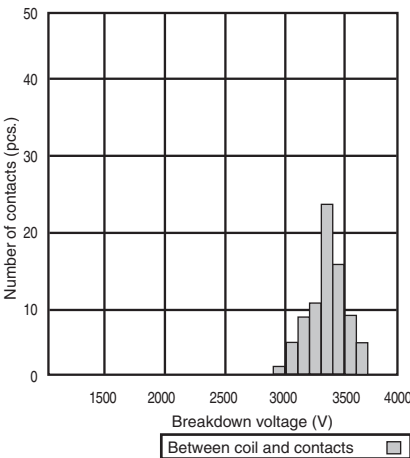

Dimensions

Note: 1. All units are in millimeters unless otherwise indicated.
 2. Coplanarity is 0.1 mm max.

Standard

G6S-2F, G6S-2F-Y

Tolerance: ± 0.3

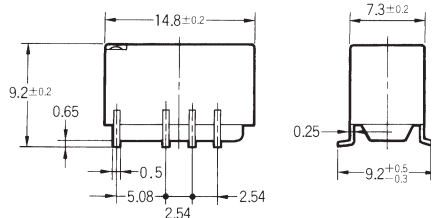
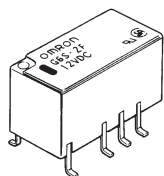

Terminal Arrangement/ Internal Connections (Top View)

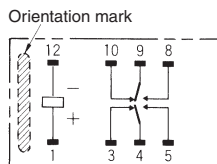

Footprint (Top View)

Tolerance: ± 0.1

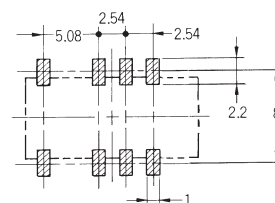

G6S-2G, G6S-2G-Y

Tolerance: ± 0.3

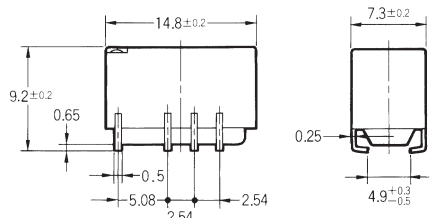
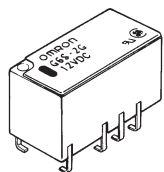

Terminal Arrangement/ Internal Connections (Top View)

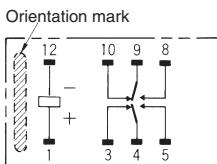

Footprint (Top View)

Tolerance: ± 0.1

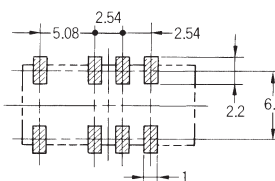

G6S-2, G6S-2-Y

Tolerance: ± 0.3

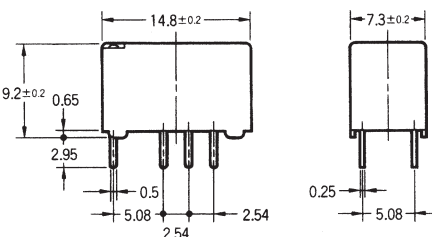
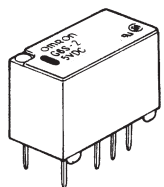

Terminal Arrangement/ Internal Connections (Bottom View)

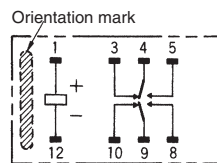

Footprint (Bottom View)

Tolerance: ± 0.1

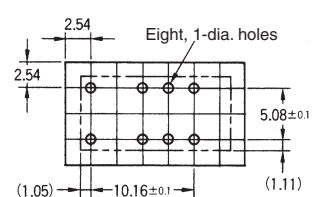

Single Coil Latching

G6SU-2F

Tolerance: ± 0.3

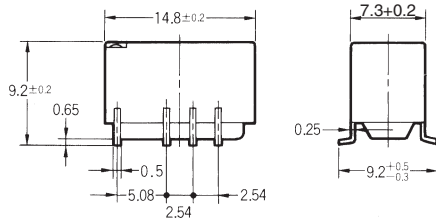
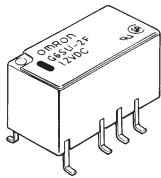

Terminal Arrangement/
Internal Connections
(Top View)

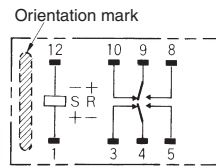

Footprint
(Top View)

Tolerance: ± 0.1

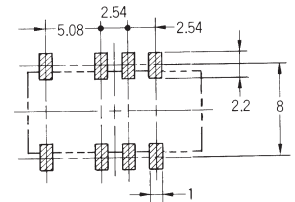

G6SU-2G

Tolerance: ± 0.3

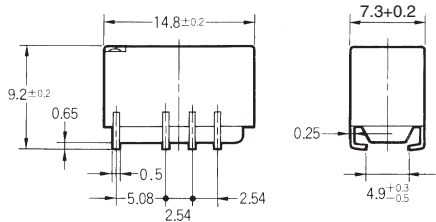
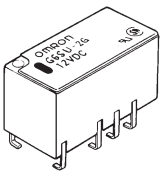

Terminal Arrangement/
Internal Connections
(Top View)

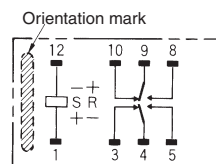

Footprint
(Top View)

Tolerance: ± 0.1

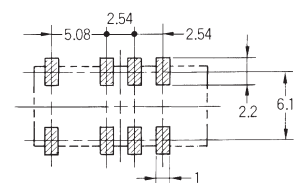

G6SU-2

Tolerance: ± 0.3

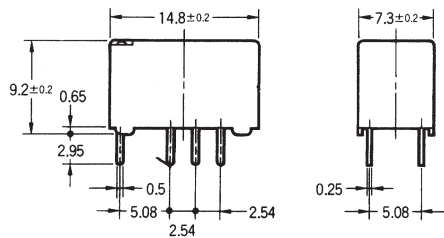
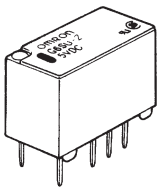

Terminal Arrangement/
Internal Connections
(Bottom View)

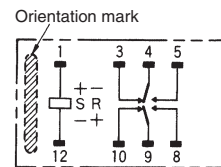

Footprint
(Bottom View)

Tolerance: ± 0.1

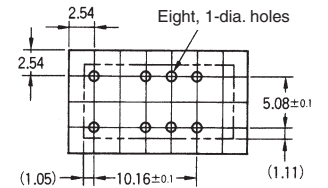

Dual Coil Latching

G6SK-2F

Tolerance: ± 0.3

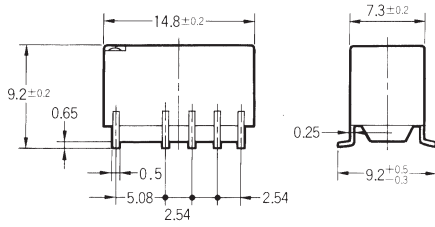
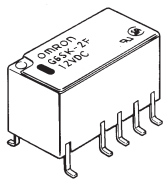

Terminal Arrangement/ Internal Connections (Top View)

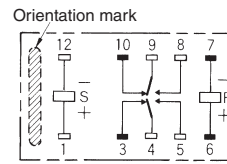

Footprint (Top View)

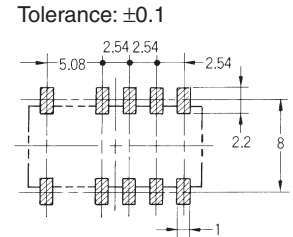

G6SK-2G

Tolerance: ± 0.3

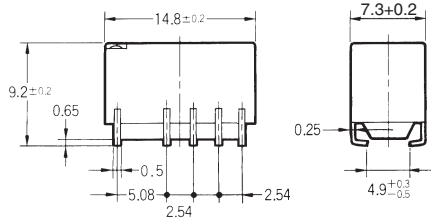
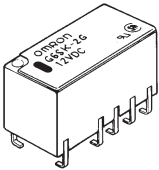

Terminal Arrangement/ Internal Connections (Top View)

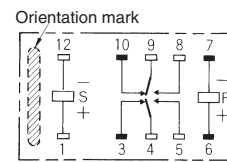

Footprint (Top View)

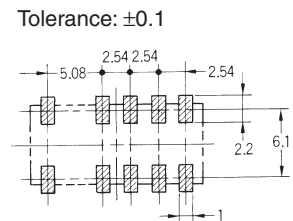

G6SK-2

Tolerance: ± 0.3

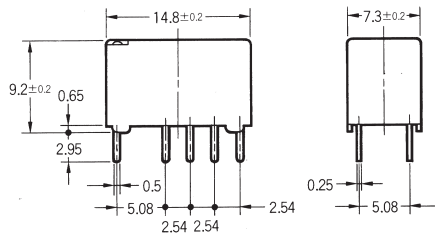
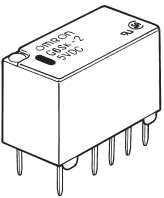

Terminal Arrangement/ Internal Connections (Bottom View)

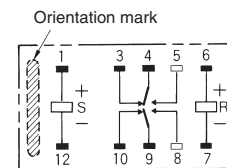

Footprint (Bottom View)

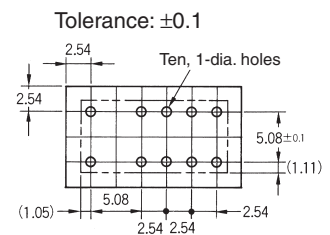

Recommended Soldering Method

(1) IRS Method (Mounting Solder: Lead)

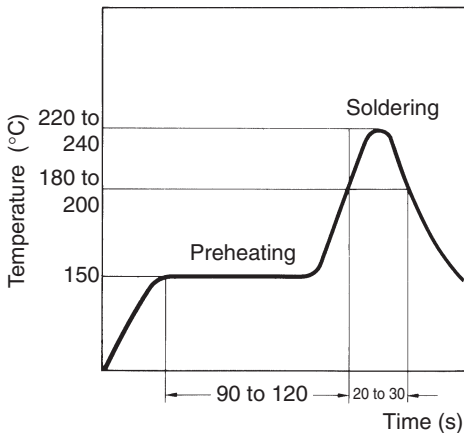

(2) IRS Method (Mounting Solder: Lead-free)

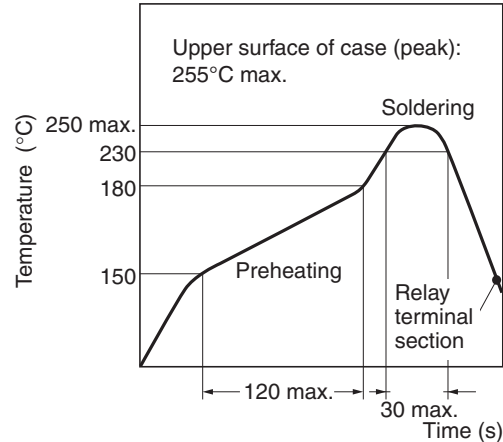

Note: The temperature profile indicates the temperature of the relay terminal section.

Packaging

Tube packing	Standard nomenclature	50 pcs per anti-static tube
Tape packing (Surface mount versions)	When ordering, add "TR" before the rated coil voltage (e.g., G6S-2F-TR-DC12) Note: TR is not part of the relay model number and will not be marked on the relay.	

■ Tape and Reel Dimensions (Surface Mount Models)

- Tape type: TE2416R (Refer to EIAJ - Electronic Industrial Association of Japan)
- Reel type: R24E (Refer to EIAJ - Electronic Industrial Association of Japan)
- Relays per reel: 400
- Reels per packing carton: 2 (800 relays)

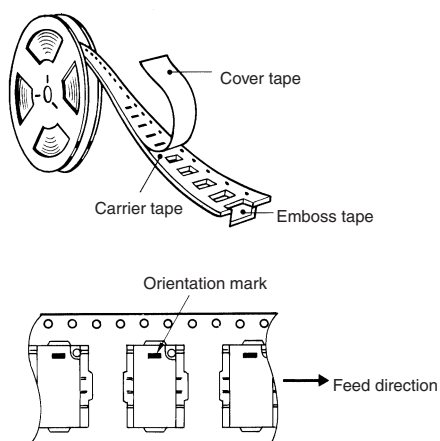
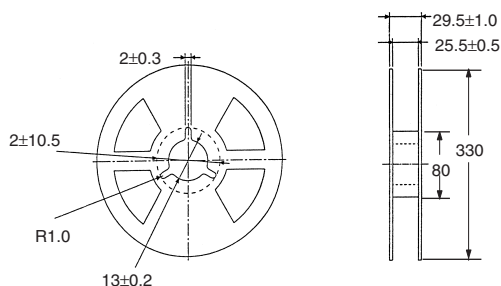

G6S-2F, G6SU-2F, G6SK-2F, G6S-2F-Y

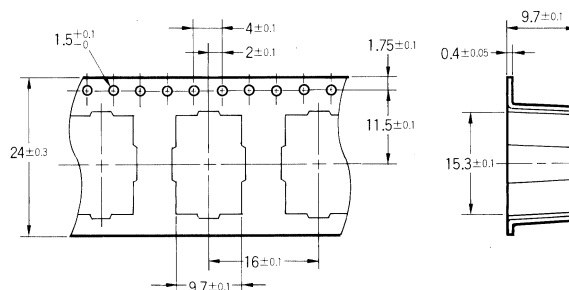

G6S-2G, G6SU-2G, G6SK-2G, G6S-2G-Y

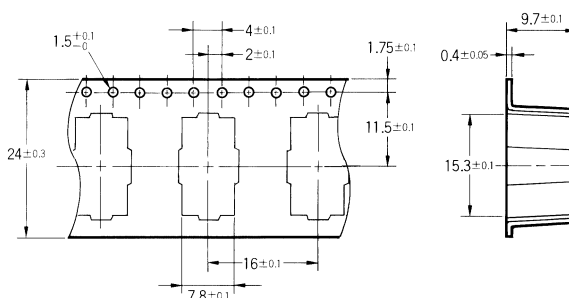

■ Approvals

UL Recognized (File No. E41515) / CSA Certified (File No. LR31928) - - Ambient Temp. = 40°C

Type	Contact form	Coil rating	Contact ratings	Number of test operations
G6S-2, G6S-2F, G6S-2G	DPDT	2 to 48 VDC	3 A at 30 VDC (Resistive)	6,000
G6SU-2, G6SU-2F, G6SU-2G		2 to 24 VDC	0.3 A at 110 VDC (Resistive)	
G6SK-2, G6SK-2F, G6SK-2G			0.5 A at 125 VAC (General Use)	
G6SK-2-Y, G6SK-2F-Y, G6SK-2G-Y				

EN60950 / EN41003

Type	Contact form	Isolation Category	Voltage
G6S-2-Y, G6S-2F-Y, G6S-2G-Y	DPDT	Supplementary Isolation	250 VAC

- Note:**
1. The rated values approved by each of the safety standards (e.g., UL and CSA) may be different from the performance characteristics individually defined in this catalog.
 2. In the interest of product improvement, specifications are subject to change.

Precautions

- Use a DC power supply with 5% or less ripple factor to operate the coil.
- Do not use the G6S where subject to strong external magnetic fields.
- Do not use the G6S where subject to magnetic particles or excessive amounts of dust.
- Do not reverse the polarity of the coil (+, -).
- Latching types are delivered in the reset position. We recommend that a reset voltage be applied in advance to start operation.
- Do not drop the G6S or otherwise subject it to excessive shock.
- Remove the relay from the packing immediately prior to usage.

■ Correct use

Long-term Continuously ON Contacts

Using the Relay in a circuit where the Relay will be ON continuously for long periods (without switching) can lead to unstable contacts because the heat generated by the coil itself will affect the insulation, causing a film to develop on the contact surfaces. We recommend using a latching relay (magnetic-holding relay) in this kind of circuit. If a single-side stable model must be used in this kind of circuit, we recommend using a fail-safe circuit design that provides protection against contact failure or coil burnout.

Relay Handling

Use the Relay as soon as possible after opening the moisture-proof package. If the Relay is left for a long time after opening the moisture-proof package, the appearance may suffer and seal failure may occur after the solder mounting process. To store the Relay after opening the moisture-proof package, place it into the original package and sealed the package with adhesive tape.

When washing the product after soldering the Relay to a PCB, use a water-based solvent or alcohol-based solvent, and keep the solvent temperature to less than 40°C. Do not put the Relay in a cold cleaning bath immediately after soldering.

G6S (K) (-U) -2 Soldering

- Soldering temperature: Approx. 250°C (At 260°C if the DWS method is used.)
- Soldering time: Approx. 5 s max. (Approx. 2 s for the first time and approx. 3 s for the second time if the DWS method is used.)
- Be sure to adjust the level of the molten solder so that the solder will not overflow onto the PCB.

Claw Securing Force During Automatic Mounting

During automatic insertion of Relays, be sure to set the securing force of each claw to the following so that the Relay's characteristics will be maintained.

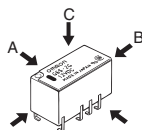

Dimension A: 1.96 N max.
Dimension B: 4.90 N max.
Dimension C: 1.96 N max.

Omron Electronic Components, LLC

Terms and Conditions of Sales

I. GENERAL

- Definitions:** The words used herein are defined as follows.
 - Terms:** These terms and conditions
 - Seller:** Omron Electronic Components LLC and its subsidiaries
 - Buyer:** The buyer of Products, including any end user in section III through VI
 - Products:** Products and/or services of Seller
 - Including:** Including without limitation
- Offer; Acceptance:** These Terms are deemed part of all quotations, acknowledgments, invoices, purchase orders and other documents, whether electronic or in writing, relating to the sale of Products by Seller. Seller hereby objects to any Terms proposed in Buyer's purchase order or other documents which are inconsistent with, or in addition to, these Terms.
- Distributor:** Any distributor shall inform its customer of the contents after and including section III of these Terms.

II. SALES

- Prices; Payment:** All prices stated are current, subject to change without notice by Seller. Buyer agrees to pay the price in effect at the time the purchase order is accepted by Seller. Payments for Products received are due net 30 days unless otherwise stated in the invoice. Buyer shall have no right to set off any amounts against the amount owing in respect of this invoice.
- Discounts:** Cash discounts, if any, will apply only on the net amount of invoices sent to Buyer after deducting transportation charges, taxes and duties, and will be allowed only if (a) the invoice is paid according to Seller's payment terms and (b) Buyer has no past due amounts owing to Seller.
- Interest:** Seller, at its option, may charge Buyer 1.5% interest per month or the maximum legal rate, whichever is less, on any balance not paid within the stated terms.
- Orders:** Seller will accept no order less than 200 U.S. dollars net billing.
- Currencies:** If the prices quoted herein are in a currency other than U.S. dollars, Buyer shall make remittance to Seller at the then current exchange rate most favorable to Seller; provided that if remittance is not made when due, Buyer will convert the amount to U.S. dollars at the then current exchange rate most favorable to Seller available during the period between the due date and the date remittance is actually made.
- Governmental Approvals:** Buyer shall be responsible for all costs involved in obtaining any government approvals regarding the importation or sale of the Products.
- Taxes:** All taxes, duties and other governmental charges (other than general real property and income taxes), including any interest or penalties thereon, imposed directly or indirectly on Seller or required to be collected directly or indirectly by Seller for the manufacture, production, sale, delivery, importation, consumption or use of the Products sold hereunder (including customs duties and sales, excise, use, turnover and license taxes) shall be charged to and remitted by Buyer to Seller.
- Financial:** If the financial position of Buyer at any time becomes unsatisfactory to Seller, Seller reserves the right to stop shipments or require satisfactory security or payment in advance. If Buyer fails to make payment or otherwise comply with these Terms or any related agreement, Seller may (without liability and in addition to other remedies) cancel any unshipped portion of Products sold hereunder and stop any Products in transit until Buyer pays all amounts, including amounts payable hereunder, whether or not then due, which are owing to it by Buyer. Buyer shall in any event remain liable for all unpaid accounts.
- Cancellation; Etc:** Orders are not subject to rescheduling or cancellation unless Buyer indemnifies Seller fully against all costs or expenses arising in connection therewith.
- Force Majeure:** Seller shall not be liable for any delay or failure in delivery resulting from causes beyond its control, including earthquakes, fires, floods, strikes or other labor disputes, shortage of labor or materials, accidents to machinery, acts of sabotage, riots, delay in or lack of transportation or the requirements of any government authority.
- Shipping; Delivery:** Unless otherwise expressly agreed in writing by Seller:
 - All sales and shipments of Products shall be FOB shipping point (unless otherwise stated in writing by Seller), at which point title to and all risk of loss of the Products shall pass from Seller to Buyer, provided that Seller shall retain a security interest in the Products until the full purchase price is paid by Buyer;
 - Delivery and shipping dates are estimates only; and
 - Seller will package Products as it deems proper for protection against normal handling and extra charges apply to special conditions.
- Claims:** Any claim by Buyer against Seller for shortage or damage to the Products occurring before delivery to the carrier or any claim related to pricing or other charges must be presented in detail in writing to Seller within 30 days of receipt of shipment.

III. PRECAUTIONS

- Suitability:** IT IS THE BUYER'S SOLE RESPONSIBILITY TO ENSURE THAT ANY OMRON PRODUCT IS FIT AND SUFFICIENT FOR USE IN A MOTORIZED VEHICLE APPLICATION. BUYER SHALL BE SOLELY RESPONSIBLE FOR DETERMINING APPROPRIATENESS OF THE PARTICULAR PRODUCT WITH RESPECT TO THE BUYER'S APPLICATION INCLUDING (A) ELECTRICAL OR ELECTRONIC COMPONENTS, (B) CIRCUITS, (C) SYSTEM ASSEMBLIES, (D) END PRODUCT, (E) SYSTEM, (F) MATERIALS OR SUBSTANCES OR (G) OPERATING ENVIRONMENT. Buyer acknowledges that it alone has determined that the Products will meet their requirements of the intended use in all cases. Buyer must know and observe all prohibitions of use applicable to the Product/s.
- Use with Attention:** The followings are some examples of applications for which particular attention must be given. This is not intended to be an exhaustive list of all possible use of any Product, nor to imply that any use listed may be suitable for any Product:
 - Outdoor use, use involving potential chemical contamination or electrical interference.

- Use in consumer Products or any use in significant quantities.
 - Energy control systems, combustion systems, railroad systems, aviation systems, medical equipment, amusement machines, vehicles, safety equipment, and installations subject to separate industry or government regulations.
 - Systems, machines, and equipment that could present a risk to life or property.
- Prohibited Use:** NEVER USE THE PRODUCT FOR AN APPLICATION INVOLVING SERIOUS RISK TO LIFE OR PROPERTY WITHOUT ENSURING THAT THE SYSTEM AS A WHOLE HAS BEEN DESIGNED TO ADDRESS THE RISKS, AND THAT THE PRODUCT IS PROPERLY RATED AND INSTALLED FOR THE INTENDED USE WITHIN THE OVERALL EQUIPMENT OR SYSTEM.
 - Motorized Vehicle Application:** USE OF ANY PRODUCT/S FOR A MOTORIZED VEHICLE APPLICATION MUST BE EXPRESSLY STATED IN THE SPECIFICATION BY SELLER.
 - Programmable Products:** Seller shall not be responsible for the Buyer's programming of a programmable Product.

IV. WARRANTY AND LIMITATION

- Warranty:** Seller's exclusive warranty is that the Products will be free from defects in materials and workmanship for a period of twelve months from the date of sale by Seller (or such other period expressed in writing by Seller). SELLER MAKES NO WARRANTY OR REPRESENTATION, EXPRESS OR IMPLIED, ABOUT ALL OTHER WARRANTIES, NON-INFRINGEMENT, MERCHANTABILITY OR FITNESS FOR A PARTICULAR PURPOSE OF THE PRODUCTS.
- Buyer Remedy:** Seller's sole obligation hereunder shall be to replace (in the form originally shipped with Buyer responsible for labor charges for removal or replacement thereof) the non-complying Product or, at Seller's election, to repay or credit Buyer an amount equal to the purchase price of the Product; provided that there shall be no liability for Seller or its affiliates unless Seller's analysis confirms that the Products were correctly handled, stored, installed and maintained and not subject to contamination, abuse, misuse or inappropriate modification. Return of any Products by Buyer must be approved in writing by Seller before shipment.
- Limitation on Liability:** SELLER AND ITS AFFILIATES SHALL NOT BE LIABLE FOR SPECIAL, INDIRECT, INCIDENTAL OR CONSEQUENTIAL DAMAGES, LOSS OF PROFITS OR PRODUCTION OR COMMERCIAL LOSS IN ANY WAY CONNECTED WITH THE PRODUCTS, WHETHER SUCH CLAIM IS BASED IN CONTRACT, WARRANTY, NEGLIGENCE OR STRICT LIABILITY. FURTHER, IN NO EVENT SHALL LIABILITY OF SELLER OR ITS AFFILIATES EXCEED THE INDIVIDUAL PRICE OF THE PRODUCT ON WHICH LIABILITY IS ASSERTED.
- Indemnities:** Buyer shall indemnify and hold harmless Seller, its affiliates and its employees from and against all liabilities, losses, claims, costs and expenses (including attorney's fees and expenses) related to any claim, investigation, litigation or proceeding (whether or not Seller is a party) which arises or is alleged to arise from Buyer's acts or omissions under these Terms or in any way with respect to the Products.

V. INFORMATION; ETC.

- Intellectual Property:** The intellectual property embodied in the Products is the exclusive property of Seller and its affiliates and Buyer shall not attempt to duplicate it in any way without the written permission of Seller. Buyer (at its own expense) shall indemnify and hold harmless Seller and defend or settle any action brought against Seller to the extent that it is based on a claim that any Product made to Buyer specifications infringed intellectual property rights of another party.
- Property; Confidentiality:** Notwithstanding any charges to Buyer for engineering or tooling, all engineering and tooling shall remain the exclusive property of Seller. All information and materials supplied by Seller to Buyer relating to the Products are confidential and proprietary, and Buyer shall limit distribution thereof to its trusted employees and strictly prevent disclosure to any third party.
- Performance Data:** Performance data is provided as a guide in determining suitability and does not constitute a warranty. It may represent the result of Seller's test conditions, and the users must correlate it to actual application requirements.
- Change In Specifications:** Product specifications and descriptions may be changed at any time based on improvements or other reasons. It is Seller's practice to change part numbers when published ratings or features are changed, or when significant engineering changes are made. However, some specifications of the Product may be changed without any notice.
- Errors And Omissions:** The information on Seller's website or in other documentation has been carefully checked and is believed to be accurate; however, no responsibility is assumed for clerical, typographical or proofreading errors or omissions.
- Export Controls:** Buyer shall comply with all applicable laws, regulations and licenses regarding (a) export of the Products or information provided by Seller; (b) sale of Products to forbidden or other proscribed persons or organizations; (c) disclosure to non-citizens of regulated technology or information.

VI. MISCELLANEOUS

- Waiver:** No failure or delay by Seller in exercising any right and no course of dealing between Buyer and Seller shall operate as a waiver of rights by Seller.
- Assignment:** Buyer may not assign its rights hereunder without Seller's written consent.
- Law:** These Terms are governed by Illinois law (without regard to conflict of laws). Federal and state courts in Cook County, Illinois have exclusive jurisdiction for any dispute hereunder.
- Amendment:** These Terms constitute the entire agreement between Buyer and Seller relating to the Products, and no provision may be changed or waived unless in writing signed by the parties.
- Severability:** If any provision hereof is rendered ineffective or invalid, such provision shall not invalidate any other provision.

Certain Precautions on Specifications and Use

1. **Suitability for Use.** Seller shall not be responsible for conformity with any standards, codes or regulations which apply to the combination of the Product in Buyer's application or use of the Product. At Buyer's request, Seller will provide applicable third party certification documents identifying ratings and limitations of use which apply to the Product. This information by itself is not sufficient for a complete determination of the suitability of the Product in combination with the end product, machine, system, or other application or use. Buyer shall be solely responsible for determining appropriateness of the particular Product with respect to Buyer's application, product or system. Buyer shall take application responsibility in all cases but the following is a non-exhaustive list of applications for which particular attention must be given:
 - (i) Outdoor use, uses involving potential chemical contamination or electrical interference, or conditions or uses not described in this document.
 - (ii) Energy control systems, combustion systems, railroad systems, aviation systems, medical equipment, amusement machines, vehicles, safety equipment, and installations subject to separate industry or government regulations.
 - (iii) Use in consumer products or any use in significant quantities.
 - (iv) Systems, machines and equipment that could present a risk to life or property. Please know and observe all prohibitions of use applicable to this product.

NEVER USE THE PRODUCT FOR AN APPLICATION INVOLVING SERIOUS RISK TO LIFE OR PROPERTY WITHOUT ENSURING THAT THE SYSTEM AS A WHOLE HAS BEEN DESIGNED TO ADDRESS THE RISKS, AND THAT THE OMRON PRODUCT IS PROPERLY RATED AND INSTALLED FOR THE INTENDED USE WITHIN THE OVERALL EQUIPMENT OR SYSTEM.
2. **Programmable Products.** Seller shall not be responsible for the user's programming of a programmable product, or any consequence thereof.
3. **Performance Data.** Performance data given in this publication is provided as a guide for the user in determining suitability and does not constitute a warranty. It may represent the result of Seller's test conditions, and the users must correlate it to actual application requirements. Actual performance is subject to Seller's Warranty and Limitations of Liability.
4. **Change in Specifications.** Product specifications and accessories may be changed at any time based on improvements and other reasons. It is our practice to change part numbers when published ratings or features are changed, or when significant construction changes are made. However, some specifications of the Product may be changed without any notice. When in doubt, special part numbers may be assigned to fix or establish key specifications for your application. Please consult with your Seller representative at any time to confirm actual specifications of purchased Product.
5. **Errors and Omissions.** The information in this publication has been carefully checked and is believed to be accurate; however, no responsibility is assumed for clerical, typographical or proofreading errors, or omissions.
6. **RoHS Compliance.** Where indicated, our products currently comply, to the best of our knowledge as of the date of this publication, with the requirements of the European Union's Directive on the Restriction of certain Hazardous Substances ("RoHS"), although the requirements of RoHS do not take effect until July 2006. These requirements may be subject to change. Please consult our website for current information.

Complete "Terms and Conditions of Sale" for product purchase and use are on Omron's website at <http://www.components.omron.com> – under the "About Us" tab, in the Legal Matters section.

ALL DIMENSIONS SHOWN ARE IN MILLIMETERS.

To convert millimeters into inches, multiply by 0.03937. To convert grams into ounces, multiply by 0.03527.

OMRON®

**OMRON ELECTRONIC
COMPONENTS LLC**

55 E. Commerce Drive, Suite B
Schaumburg, IL 60173

847-882-2288

OMRON ON-LINE

Global - <http://www.omron.com>

USA - <http://www.components.omron.com>